



OIE Virtual Training Series on Rabies Diagnosis for SAARC Region

5-6 November 2020

FINAL TRAINING REPORT



Veterinary College, Bengaluru

Organised by

World Organisation for Animal Health (OIE)

and

**KVAFSU-CVA Rabies Diagnostic Laboratory
OIE Reference Laboratory for Rabies
Department of Veterinary Microbiology
Veterinary College, KVAFSU, Hebbal, Bengaluru - 560024
Karnataka, INDIA**

Organizers of the training programme

Contributors from KVAFSU:

Patron: Dr. H.D. Narayanaswamy, Hon'ble Vice Chancellor, KVAFSU

Chief Coordinator: Dr. M. Narayana Bhat, Dean, Veterinary college, Bengaluru

Organizing Secretary: Dr. Shrikrishna Isloor, Laboratory Director, KVAFSU-CVA-RDL & Associate Professor, Department of Microbiology

Coordinators:

Dr. D. Rathnamma, Biosafety Officer, KVAFSU-CVA-RDL and Professor & Head, Department of Microbiology

Dr. Sharada, R., Quality Manager, KVAFSU-CVA-RDL & Assistant Professor, Department of Microbiology

Co-Coordinator: Mr. Dilip, L., Technical Manager, KVAFSU-CVA-RDL.

Support:

Dr. G. Kavitha, Analyst -1, KVAFSU-CVA-RDL & PhD scholar, Department of Microbiology

Dr. Samrudh, M.C., Analyst -2, KVAFSU-CVA-RDL & Sr. MVSc student, Department of Microbiology

Dr. Hridya, S.V., Analyst -3, KVAFSU-CVA-RDL & Ph D scholar, Department of Microbiology

Mrs. Harshita, N., Data Entry Operator, KVAFSU-CVA_RDL.

Contributors from OIE RRAP:

Dr Hirofumi Kugita, Regional Representative, OIE Regional Representation for Asia and the Pacific (RRAP), Tokyo, Japan

Dr Kinzang Dukpa, Regional Project Coordinator, OIE RRAP

Dr Lesa Thompson, Regional Project Officer, OIE RRAP

Dr Asako Endo, Regional Veterinary Officer, OIE RRAP

Dr Pasang Tshering, Consultant, OIE RRAP

Training Manual Prepared by



Dr. Shrikrishna Isloor
Laboratory Director



Dr. D. Rathnamma
Biosafety Officer



Dr. R. Sharada
Quality Manager



Mr. Dilip, L.
Technical Manager



Dr. Kavitha, G.
Analyst-1



Dr. Samrudh, M.C.
Analyst-2



Dr. Hridya, S.V.
Analyst-3



Mrs. Harshitha, N.
Data Entry Operator

Table of Contents

Introduction	5
Objectives	5
Topics and methodology	5
Key outputs.....	6
Regional Situation of Rabies Diagnostic Capacity in the SAARC Region.....	7
Introduction of the KVAFSU-CVA Rabies diagnostic Laboratory	8
Occipital foramen approach for brain sampling, including sample preparation, sample transport and sample preservation	9
Brain sample collection through Occipital foramen approach.....	10
Transportation of Samples to the Laboratory	13
Transportation of Specimen without Preservatives	13
Transport Using Preservative Solutions	13
Lateral Flow Immunoassay	15
Principles of Lateral Flow Immunoassay	16
Direct Fluorescent Antibody (DFA) test	19
Principles of Immunofluorescence	19
DFA Protocol:.....	22
Documentation and reporting	26

Table 1. Status of rabies diagnostic capacity at the human and animal disease diagnostic laboratories in the SAARC region.....	7
--	---

Annexures 1. Training Agenda.....	32
Annexures 2. List of participants.....	33
Annexures 3. Quiz questions and answers	36
Annexures 4. Summary of training evaluation.....	37
Annexure 5. Q & A.....	40
Annexures 6. Training in pictures	44

Introduction

Rabies is endemic in both humans and animals in seven of the eight South Asian Association for Regional Cooperation (SAARC) Members States (MSs), contributing to about 45% of the global burden of human rabies. Over 95% of human rabies cases are associated with dog bites. Rabies control and subsequent elimination necessitates a multi-sectoral collaboration, using a One Health approach.

In June 2019, the OIE with its Tripartite partners (FAO and WHO) organised the SAARC Tripartite Rabies Workshop on “*Enhancing Progress Towards Rabies Elimination ‘Zero by 30’ in the SAARC Region*” in Nepal. The meeting recommended that the SAARC MSs enhance their rabies surveillance activities through strengthening rabies diagnostic capacities at national, sub-national and local levels. At the webinar on rabies for SAARC in May 2020, the need to enhance ground-level rabies surveillance by imparting training on rabies diagnosis was highlighted.

Therefore, the OIE Regional Representation for Asia and the Pacific (RRAP) in collaboration with the Karnataka Veterinary, Animal and Fisheries Sciences University (KVAFSU)- Commonwealth Veterinary Association (CVA) - Rabies Diagnostic Laboratory (KVAFSU-CVA-RDL) organized a virtual training on rabies diagnosis for the SAARC MSs on 5th and 6th of November 2020. The OIE, on 16 June 2020, designated the KVAFSU-CVA RDL as the OIE Reference Laboratory for Rabies, with Dr Shrikrishna Isloor as the designated rabies expert. The KVAFSU-CVA RDL can now provide the required facilities and skills for training on rabies diagnosis.

Objectives

The training was organised with the following objectives.

- To enhance laboratory diagnostic capacity of SAARC MSs for rabies diagnosis.
- To enhance rabies surveillance capacities on the ground, thereby enhancing disease detection, reporting and control activities.
- To develop networking and coordination between rabies diagnostic laboratories in SAARC MSs and with the KVAFSU-CVA RDL, OIE Reference Laboratory for Rabies.

Topics and methodology

The participants were trained on the OIE recommended occipital foramen approach for brain sampling, lateral flow immunoassays (LFA), and the direct fluorescent antibody test (DFA) over the two days period of 3 hours session each (Annexure 1).

Although, an array of laboratory tests are now available for diagnosis of rabies, many countries still face challenges in sampling and sample transportation. Currently, animal health staff/laboratory technicians still use the conventional method of sending the whole animal, decapitated head or brain samples collected after opening the skull. This can be particularly difficult under the field conditions in remote areas and in tropical countries, where the field worker has not only to find suitable containers to pack bulky specimens but also the availability of vehicles and manpower for the transportation of carcass to the laboratory. Such conventional invasive method of sampling by opening skull cap is laborious, time consuming, risky, and delicate procedure that should be performed by well-trained person. Such invasive procedure also puts the handler at risk and requires special precautions to avoid accidental exposure to the virus through wounds or by spillage/aerosols. In view of these limitations, the OIE has been recommending the use of occipital foramen method (non-invasive method) of brain sampling from rabies suspected animals wherein brain samples can be collected without opening the skull. Therefore, this training’s focus was on the occipital foramen technique of sampling which is a safe, rapid, and user-friendly technique that can be easily applied even in the field conditions.

Rabies diagnosis in most SAARC MSs are undertaken at national/state level and to some extent at sub-national levels. There is generally a lack of knowledge and accessibility to diagnostic tools in the districts/villages which undermines rabies surveillance on the ground. Rapid detection and laboratory confirmation of animal rabies cases is crucial to mount timely control measures to prevent further spread of the disease. Therefore, this first series training also focused on lateral flow assays that could be used for rabies diagnosis at the ground-level and DFA which is the gold-standard test for rabies diagnosis.

The training was undertaken using power point presentations, pre-recorded videos, and live interactive sessions with the experts from the OIE reference laboratory. At the end of the training sessions on each day, participants actively participated in the Q&A session that made the training more interactive and interesting (Q&A output attached).

Key outputs

The training was officially opened after a series of opening keynote addresses made by Dr Hirofumi Kugita, Regional Representative, OIE RRAP; Dr H.D. Narayanaswamy (Vice Chancellor) and Dr M. Narayana Bhat (Dean) from KVAFSU; Dr S. Abdul Rahman from CVA, and Dr Praveen Malik, Animal Husbandry Commissioner from the Department of Animal Husbandry and Dairying, Government of India (GOI). All the speakers appreciated the joint initiative by OIE and KVAFSU in undertaking this training and pledged their support to enhance rabies control activities in the SAARC region for achievement of the global goal of 2030.

A total of 24 laboratory diagnosticians/veterinarians working on animal rabies surveillance/control from seven Member States of South Asian Association for Regional Cooperation (Bangladesh, Bhutan, India, Maldives, Nepal, Pakistan, and Sri Lanka) attended the virtual training (Annexure 2). Topics on occipital foramen approach of brain sampling (OIE recommended), sample preservation, sample transportation; the use of lateral flow immunoassays; and the direct fluorescent antibody (DFA) techniques were explained in detail using both theoretical and practical sessions. Pre-recorded videos were shown for the three topics and the trainers explained in detail the standard operating procedures for each topic. Dr Shrikrishna Isloor (OIE expert on rabies) led the training supported by his team from the KVAFSU.

The training was well received with 46% and 54% of the trainees assessing the training webinar as “satisfactory” and “highly satisfactory”, respectively. Likewise, 71% of the trainees reported “significant impact” on their technical knowledge on rabies. In the quiz applied before the training, the average score was 56.5% which increased to 83% at the end of the training (Annexure 3 for details of quiz question). Some feedback from the trainees included: requesting OIE to consider live practical demonstration in the field (simulating actual outbreak scenario); requesting OIE for more training on handling fluorescent microscope; requesting OIE for future trainings on molecular techniques, dRIT, RFFIT, diagnosis in live animals, serology (see details on training feedback in Annexure 4).

The participants actively participated in the training with several questions being asked to the trainers. A summary of the Q & A is available in Annexure 5.

Regional Situation of Rabies Diagnostic Capacity in the SAARC Region

Pasang Tshering

Prior to the tripartite SAARC Rabies Webinar held on 18-20 May 2020, a questionnaire survey was conducted in the South Asian Association for Regional Cooperation (SAARC) Members to collect information on rabies situation, status of laboratory capacities, preparedness and response plans, and activities in the region in progressing towards elimination of dog-mediated human rabies by 2030. Data for both human and animal health sectors were collated. Seven of the eight SAARC Members have diagnostic capacities for animal rabies diagnosis and only four countries reported they have diagnostic facilities for the human health sector. Although Maldives did not participate in the survey in May 2020, during this training it was confirmed that Maldives do not currently undertake any laboratory diagnostic tests for rabies but intend to soon develop their diagnostic capacity in view of the threat of incursion. In Bhutan, if required, arrangements have been made to test human samples for rabies diagnosis at the National Centre for Animal Health.

Table 1. Status of rabies diagnostic capacity at the human and animal disease diagnostic laboratories in the SAARC region

Country	Diagnostic tests employed in animal health sector	Diagnostic tests employed in human health sector
Afghanistan	Direct Fluorescent Antibody (DFA) Test and Real time RT-PCR, Rapid Antigen detection test	No testing
Bangladesh	Direct Fluorescent Antibody (DFA)	Fluorescent Antibody Test (FAT)
Bhutan	DFA & Rapid Antigen detection	No testing
Nepal	DFA and Mouse Inoculation Test (MIT), Rapid Antigen detection test	No testing
India	Direct rapid immunohistochemical test (dRIT), DFA, Enzyme linked Immunosorbent Assay (ELISA); Cell culture (virus isolation); MIT, Conventional RT-PCR, Real-time RT-PCR, Lateral Flow Immunoassay(LFA)	FAT; dRIT; Real-time RT-PCR); Rapid Fluorescent Focus Inhibition Test (RFFIT)
Pakistan	MIT	Conventional RT-PCR
Sri Lanka	DFA and MIT	FAT

For the animal health sector, Afghanistan, Bhutan, India, Nepal & Sri Lanka have diagnostic facilities available at both national and sub-national levels. Bangladesh has rabies diagnostic facility at national level only and Pakistan has it at sub-national level only.

For the human health sector Bangladesh, Sri Lanka and Pakistan reported having laboratory testing facilities at national level and India at sub-national level. Afghanistan, Nepal and Bhutan do not have any testing laboratory facility.

Introduction of the KVAFSU-CVA Rabies diagnostic Laboratory

Shrikrishna Isloor, D. Rathnamma, Sharada, R.

The Veterinary College, Bengaluru was established on 25th July 1958 and became a constituent college of the University of Agricultural Sciences in 1965. It became part of the newly established Karnataka Veterinary, Animal and Fisheries Sciences University (KVAFSU), Bidar from April 2005. The college is located on the Bengaluru to Hyderabad highway at a distance of about 28 KM from the Kempegowda International Airport. The main focus of the Veterinary College is teaching, research and extension and is collaborating with various overseas universities and institutes including the Centre for Disease Control and Prevention (CDC), Atlanta, US, Animal and Plant Health Agency (APHA), UK, Virginia Tech, Blacksburg, University of Minnesota, Kansas State University, Ohio State University, US, University of Purdue, Curtin University of Technology, Perth, Western Australia and INSERM, France. In addition, the Veterinary College has been involved in animal rabies related research activities for the last 40 years. With the establishment of the dedicated KVAFSU-CVA Rabies Diagnostic Laboratory in 2013 (as a part of collaborative project involving KVAFSU, CVA and Crucell Holland B.V., Netherlands), a BSL-II Laboratory, the support for animal rabies research activities, especially diagnosis of animal rabies was strengthened. Furthermore, the laboratory was twinned with the Animal and Plant Health Agency (APHA), Weybridge, UK and CDC, Atlanta, GA, US under the OIE Twinning programme with the mandate of 'Strengthening the diagnosis of Rabies in India'. The laboratory has also developed a network of rabies diagnostic facilities as per the standard detection methods in other parts of the country. In addition to these, molecular studies such as PCR / LN 34 real-time PCR assay for the pan Lyssa viruses are being carried out for understanding the molecular epidemiology of rabies virus lurking in different parts of India. The phylogenetic analyses based on complete N and G gene sequences has revealed that, some sequences from southern parts of India cluster closely with sequences of rabies virus isolates from Sri Lanka. The rabies viral N and G protein amino acid sequences showed that the viral isolates recovered belong to genotype 1 and are similar.

In addition to the diagnosis and research activities, capacity building of veterinarians from different parts of the country, involved in rabies diagnosis is being undertaken by holding regular workshops and training programmes on rabies diagnosis. Since the establishment of the Laboratory, about 450 veterinarians from different regionally representative states of India have been trained. This has been done in collaboration with the support from CVA, CDC, Atlanta and APHA, UK.

The laboratory was designated as the 'OIE Reference Laboratory for Rabies' on 16th June 2020 and it can serve the needs of not only India but other South Asian and South East Asian countries with respect to animal rabies research related activities and can serve as a centre of excellence in animal rabies, with main areas of focus being diagnosis of animal rabies and surveillance. It can undertake statutory diagnostic services and provide support to research projects for rabies and rabies-related viruses in the region. The expertise available at the laboratory could provide international test and disease consultancy services in the region. Additionally, the laboratory will be able to provide consultancy in disease surveillance on rabies and non-rabies lyssaviruses, control strategies and diagnostics.

The laboratory will act as a national hub for animal rabies in India. Additionally, the laboratory will work in close collaboration with the WHO Collaborating Centre for Reference and Research in Rabies at the National Institute of Mental Health and Neuro Sciences (NIMHANS), Bengaluru as part of a One Health rabies strategy for the elimination of dog-mediated human rabies in India. Furthermore, the laboratory will continue to collaborate with other OIE Reference Laboratories for rabies, and in the future

will also work more closely as part of a community of practice with other OIE Reference Laboratories for rabies.

The laboratory is also committed to offer in-house or out-reach training in diagnostics, epidemiology as a tool to design and improve control measures. As an OIE reference laboratory, the activities of the OIE with reference to diagnosis and control of rabies in animals will be supported in addition to offering consultancy, training, quality assurance testing and inter-laboratory comparisons. The training can be provided on site at Veterinary College, KVAFSU, Hebbal, Bengaluru or can also be organized in the other regional laboratories and veterinary universities. In general, training can cover various diagnostic approaches such as immunological, molecular and cell culture methods, epidemiological and strategies for active surveillance followed by evaluation of strategies to control rabies in an area. The laboratory also collaborates with the public and private sectors in the field of development and evaluation of diagnostic assays and applied research.

Occipital foramen approach for brain sampling, including sample preparation, sample transport and sample preservation

Shrikrishna Isloor, Dilip, L. and Samrudh, M.C.

The diagnostic methods used in this document are written according to the OIE [Manual](#) of Diagnostic Tests and Vaccines for Terrestrial Animals 2019 except for the lateral flow assays. For more details, readers are directed to read the OIE Manual.

Laboratory based diagnosis of rabies has to be accurate and rapid as it is critical for initiating post-exposure prophylaxis and public health control strategies. Various methods are used for the diagnosis of the disease. However, proper collection and submission of post-mortem specimens with special reference to brain tissues from animals suspected for rabies constitute the basis for confirmatory diagnosis of rabies.

Brain material from animals may be submitted by veterinarians as part of their diagnostic process, regardless of bite or other exposure status. Keeping this in view, the below information is useful to facilitate the handling and provide the most accurate and rapid diagnosis of rabies in animals.

Preliminary Safety

All individuals and laboratory personnel involved in the handling of rabies suspected cases should undergo pre-exposure immunization and regular boosters as required. These personnel are at risk of rabies infection through various means such as accidental injection or contamination of mucous membranes with rabies virus contaminated material and by exposure to aerosols of rabies infected material. Hence, personal protective equipment (PPE) must be used at all levels starting from necropsy procedure. All manipulations of tissues and slides should be conducted in a manner that does not aerosolize liquids or produce airborne particles. Barrier protection is required for safe removal of brain tissue from animals submitted for rabies testing. At a minimum, barrier protection during necropsy should include the following as Personal Protective Equipment (PPE): gloves, laboratory gown and waterproof apron, boots, surgical masks, protective sleeves, and a face shield. Care should be taken to protect eyes and hands during manipulation of tissues.

Identification of Agent

As rabies virus tends to get rapidly inactivated, the specimens collected should be sent on ice to the laboratory by the fastest means available. Various techniques are employed to diagnose rabies particularly employed on brain tissue. For laboratory diagnosis, both cerebellum and brain stem are recommended to be collected since the virus will be present in abundance in these and aid laboratory diagnosis. These parts of the brain can be obtained after removing the entire brain through the skull open method during necropsy.

Collection of Samples

In a rabies-infected animal, the brain, spinal cord, saliva, salivary glands may contain the virus, and fresh, non-fixed tissue is acceptable for diagnosis of the disease. The brain tissue is the choice of specimen for rabies diagnosis. Although animal heads are accepted for diagnosis, care should be taken so that the neck should be severed at the midpoint between the base of the skull and shoulders. Only veterinarians or animal control officers who have been vaccinated and perfectly trained should remove the animal heads. The post-mortem should be done in a ventilated area using protective gear. After opening the skull, appropriate samples like the brain stem and cerebellum are collected. This is a laborious task and hazardous too in field conditions or even when the person is not well trained. An alternate method of brain sample collection without the need to break open the skull has been developed and is referred to as the **Occipital foramen route of brain sampling** and this is one of the OIE recommended sampling techniques for rabies diagnosis.

Brain sample collection through Occipital foramen approach

General requirements

1. Personal protective equipments

- Disposable gloves
- Face mask
- Eye goggles
- Hair cover
- Disposable apron
- Shoe cover

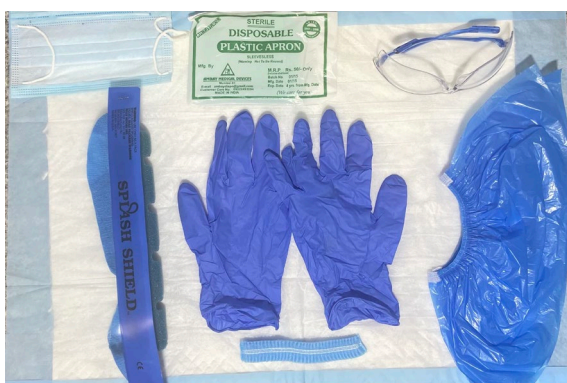

2. Sample collecting equipment:

- Scissors (sharp and blunt ended)
- Forceps
- BP blade plus holder
- Artificial insemination sheath (AI sheath)
- Disposable syringes
- Sample storage containers.



First, locate the transverse processes of the first cervical vertebra (Wings of Atlas) and external occipital protuberance.

EXTERNAL OCCIPITAL PROTUBERANCE

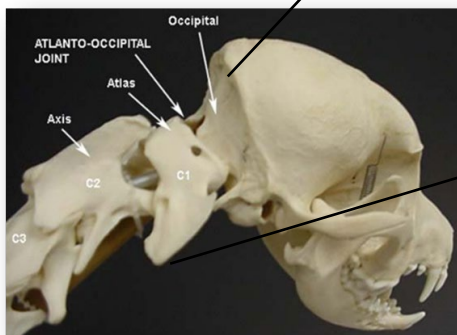

TRANSVERSE PROCESS OF C1 (WINGS OF ATLAS)

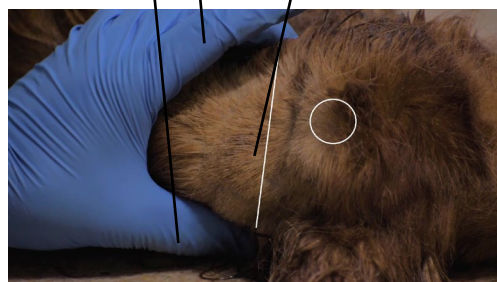

A deep cut is made just behind external occipital protuberance but anterior to imaginary line connecting the transverse processes of the first cervical vertebra, Severing the skin, cutaneous fascia, cervicocutularis muscle, splenius, brachiocephalicus muscles and the insertion point of nuchal ligament to expose Occipito-atlantal joint



Dislocate the joint using a sharp disposable BP blade. This exposes the foramen magnum which seats some parts of pons, medulla oblongata and major parts of brainstem. Using scalpel/BP blade, the brain stem portion visible is cut and the specimen is collected into the primary container.



Further, introduce an artificial insemination (AI) sheath or plastic drinking straw connected to a disposable syringe deeply into the foramen magnum and the tissue from brain stem aspirated into the AI sheath.



Collect the brain sample in a sample storage container and send to laboratory for further processing.



The Occipital foramen approach of brain sample collection is reported to be user-friendly, rapid and risk-free for accurate diagnosis of rabies. This encourages collection and submission of more number of brain samples from the field for the laboratory confirmation.

Transportation of Samples to the Laboratory

The specimens collected shall be transported to the laboratory at the earliest either by post or by courier or by air as suitable. The specimens suspected for rabies should be shipped on ice in a leak-proof container to the laboratory so that it does not pose a threat of contamination. Any undue delay can wither away the cooling effect of ice especially in tropical climates enhancing putrefaction of sample making it unsuitable for diagnosis. If it is not possible to send the samples in a refrigerated condition, other preservation techniques may also be used. The preservative used shall be based on the tests to be employed for diagnosis. However, in most of the situations, either the brain sample may be packed as such without any preservatives or shipped in glycerol saline in refrigeration.

Transportation of Specimen without Preservatives

This is the most commonly used method of submitting samples to a diagnostic laboratory. If only the cerebellum and brain stem are transported, these should be first placed in a sealed, rigid container and then labelled. The primary package is then placed in a secondary container which is also tightly sealed and further put in an insulated container preferably made of expanded polystyrene. Absorbing materials to prevent leakage and cooling materials are placed in this tertiary container and finally sealed with an adhesive tape. The information relevant to the sample is placed in an envelope and attached on the outer surface of the box. The box should be labelled clearly as “BEWARE! BIOLOGICAL SPECIMEN FOR RABIES DIAGNOSIS. INFECTIOUS HAZARD!”

If the head of the suspected animal is being submitted, as soon as the head is separated from the body of the animal, the specimen has to be first cooled in a refrigerator. The entire head when collected should be wrapped in absorbing paper and then placed in resistant plastic bag.

Transport Using Preservative Solutions

Preservative solutions are used if transit time to the laboratory is long or if transportation on refrigerants is not possible. The laboratory technique that is used for diagnosis determines the preservative to be used.

- The use of formalin solution is safe since it inactivates the rabies virus, but the sample becomes unsuitable for isolation / inoculation tests. These specimens are suitable for histological studies only.
- Specimens can also be transported in glycerine solution which does not inactivate the virus rapidly but is capable of inhibiting the growth of contaminants temporarily.

Note: The DFA test may be applied to glycerol-preserved specimens after a washing step. If the specimen has been preserved in formalin solution, the DFA test may be used only after the specimen has been treated with a proteolytic enzyme. **However, the DFA test on formalin-fixed and digested samples is always less reliable and more cumbersome than when performed on fresh tissue.**

Preservative Solutions for Diagnosis

For transit over short distances, the specimens for diagnosis of rabies are sent on ice in wide-mouth leak-proof containers. If the transit time is longer, samples are placed in preservative solutions as described below

- a) One half of the brain in either 10% formal saline or Zenker’s fluid and the other half in 50%



- glycerol saline
- b) Salivary glands in 50% glycerol saline
- c) CSF, saliva and urine are transported in tissue culture medium with 2% saline
- d) Specimens for cytological tests or histopathological diagnosis are transported in 10% neutral buffer formalin or in Bouin's solution
- e) Preservation for molecular techniques:
 - lysis buffers for nucleic acid extraction and RNA preservation buffers impregnated onto filter paper can be used.
- These buffers preserve rabies virus RNA and allow transport of specimens at ambient temperature without specific biohazard precautions for detection of viral RNA and further genetic characterization of rabies virus strains. In packaging, the materials capable of causing injury shall be avoided.

Labelling of the Specimen

The specimen container should be properly labelled using permanent markers before dispatching it to the laboratory. The label should inform about the date of collection, species, type and number of samples being sent along with the preservative used. The parcel should also be appropriately labelled.

Sample Submission Format

The sample submission format accompanying the specimen sent should be complete providing all the necessary information like detailed history of the case, species and breed of an animal infected, vaccination history, clinical signs observed, probable contact with other animals/humans, the mode and date of death, etc. This ensures proper identification of the animal and proper reporting of results.

 KARNATAKA VETERINARY, ANIMAL AND FISHERIES SCIENCES UNIVERSITY, BIDAR KVAFSU-CVA RABIES DIAGNOSTIC LABORATORY  OIE REFERENCE LABORATORY FOR RABIES DEPARTMENT OF VETERINARY MICROBIOLOGY, VETERINARY COLLEGE, HEBBAL, BENGALURU - 560 024. 	
FORMAT	
FOR DIAGNOSIS OF RABIES IN SUSPECTED SAMPLES	
1	Species of Animal
2	Stray / Owned Stray <input type="checkbox"/> Owned <input type="checkbox"/>
3	(Name& Address along with Ward No., if Owned) (Location and Ward No. , if Stray)
4	Sample Submitted by Name& Address
5	Contact details: E-mail: Phone No.: Mobile No.:
6	Reference No.
7	Clinical Signs and Symptoms
7	Gender Male <input type="checkbox"/> Female <input type="checkbox"/>
8	Breed
9	Age
10	Colour
11	Vaccination details Notched / Non notched
12	Date of Sample collection / Date of Post mortem
14	Sample type
Note: Brain samples should be sent in cold chain	
Signature of the clinician	

Materials Suggested for Use and Proper Handling of the Specimen

1. Primary Container

This contains the clinical specimen and hence should be a rigid one which can be tightly sealed.

The plastic containers of appropriate size can be used.

2. Secondary Container

The primary container is placed in a secondary container. This can preferably be a plastic or metal container with a lid or even **a suitable zip lock bag**.

3. Tertiary/Shipping Container

The secondary container is then placed in the **tertiary / shipping container** which is a thick-walled container with or without an exterior fibre board liner such as a **thermocool box**. Frozen cool packs and cushioning materials are put in these containers to prevent damage to the specimen during transport. This container should be labelled as “BEWARE! BIOLOGICAL SPECIMEN FOR RABIES DIAGNOSIS. INFECTIOUS HAZARD!”

In conclusion, the specimens collected for rabies diagnosis are infectious, and thus appropriate precautions should be taken during handling and transportation to ensure the safety of the personnel and the environment involved like the sample collector/submitter, transportation carriers, laboratory staff and the public at large. The samples should be transported on ice to prevent their decomposition. Frozen cold packs are preferred over wet ice since it may leak through the container resulting in rejection of the specimen. Triple packaging of the sample is preferred. If more than one specimen is transported, each specimen should be packaged in a separate primary container properly labelled and then placed in a secondary container. The tertiary container should be cleaned on its outside surface with a disinfectant to reduce the risk of exposure to anyone handling the package. Proper packaging helps in proper maintenance of the samples to aid accurate diagnosis of rabies.

Lateral Flow Immunoassay

Rathnamma, D and Hridya, S.V.

Lateral flow immunoassay (LFA) is a well-established valuable tool in medical, veterinary, food, agricultural, environmental health and safety and industrial testing etc. While in many instances it is used as a rapid screening tool and backed up by more complex and time-consuming assays. It may also be used in some applications as the primary method of choice. This test is an immunochromatographic assay being used for the qualitative detection of either antigen or antibody in the specimen.

The common components of a lateral flow assay and the standard materials used for each component are described below.

The most important component is the analytical region i.e., nitrocellulose membrane. The purpose of the analytical region in a lateral flow immunoassay is to bind proteins at the test and control areas and to maintain their stability and activity over the shelf-life of the product. When the test is run, it must accept the conjugate and sample from the conjugate pad, flow them consistently to the reaction area, allow the reaction at the test and control lines to happen, and allow excess fluids, label, and reactants to exit without binding. The material of choice in the vast majority of lateral flow immunoassay systems has historically been nitrocellulose. Several attempts have been made to introduce other material types into the market, including nylon and polyvinylidene fluoride (PVDF) membranes. However, those attempts have had limited success, apparently due to factors including

cost, limited utility, the need for education regarding new chemistry and processing requirements, and resistance to change due to the large bank of existing experience in the use of nitrocellulose. Nitrocellulose membrane remains the only material that has been successfully and widely applied in this way to date. The advantages of nitrocellulose membrane include relative low cost, true capillary flow characteristics, high protein-binding capacity, relative ease of handling and a variety of available products with varying wicking rates and surfactant contents.

The schematic representation of typical configuration of lateral flow immunoassay is as follows:

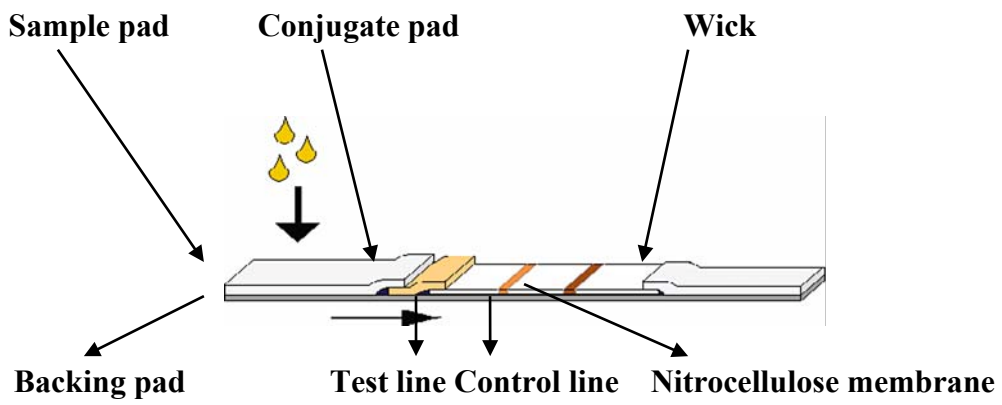

Traditionally designed lateral flow immune assays are composed of a variety of materials, each serving one or more purposes. The parts overlap onto one another and are mounted on a backing card using a pressure-sensitive adhesive. The assay consists of several zones, typically constituted by segments made of different materials.

Principles of Lateral Flow Immunoassay

The test principle of the lateral flow immunoassay is that when a test is run, sample is added to the sample pad. Here, the sample is treated with a suitable diluent to make it compatible with the rest of the test. The treated sample migrates through this region to the conjugate pad, where a particulate conjugate has been immobilized. The particle can typically be colloidal gold, or a coloured, fluorescent or paramagnetic monodisperse latex particle. This particle has been conjugated to one of the specific biological components of the assay, either antigen or antibody depending on the assay format. ‘Colloidal gold’ is perhaps the most widely used label today in commercial lateral flow immunoassays for many reasons. It is fairly easy and inexpensive to prepare in the laboratory. The colour is intense, and no development process is needed for visualization. The label is very stable in liquid or dried form and is non-bleaching after staining on membranes. In addition, colloidal gold in unconjugated forms (which are ready for labelling) and conjugated forms (conjugated with biologicals) are now readily available from many commercial sources. The sample re-mobilizes the dried conjugate, and the analyte in the sample interacts with the conjugate as both migrate into the next section of the strip, which is the reaction matrix. This reaction matrix is a porous membrane, onto which the other specific biological component of the assay has been immobilized. These are typically proteins, either antibody or antigen, which have been laid down in bands in specific areas of the membrane where they serve to capture the analyte and the conjugate as they migrate by the capture lines (T and C). Excess reagents move past the capture lines and are entrapped in the wick or absorbent pad. The results of the assay are interpreted on the reaction matrix as the presence or absence of coloured lines of captured

conjugate at Test (T) line and Control (C) line read either by eye or using a reader. The control (C) line is a reference line which indicates the test is performing properly. The control line has to appear in both positive and negative results when the test is performed. Results are interpreted as positive when both test line and control lines appear on the reaction matrix.

For the diagnosis of rabies in animals, ‘Rapid Rabies Antigen Test kits’ manufactured by [Bionote](#), Hwaseong-si, Korea, are being used. This test can be done on the carcass in the field and can be considered almost confirmatory although negative tests need to be confirmed using DFA or molecular tests. The test device has two lines which are test (T) line and control (C) line on the surface of the device. Test line and control line in the result window are not visible before applying samples.

The ‘Rapid Rabies Antigen Test kit’ and the materials provided along with the kit are as detailed below:

Materials provided in the kit (10 Tests/Kit):

- Rapid Rabies Ag Test devices
- Assay diluents tubes
- Disposable swabs
- Disposable droppers
- Instruction manual

Rapid Rabies Antigen Test kit (Bionote, Hwaseong-si, Korea)



Protocol:

1. All reagents and samples shall be at room temperature before use.
2. Using the disposable swab provided, collect the sample from the brain tissue or add a small piece of the brain tissue onto the diluent tube.

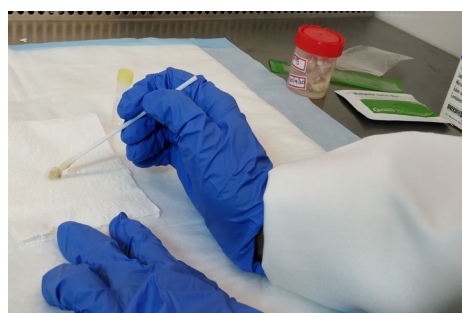

3. The swab shall be inserted into the assay diluent tube.

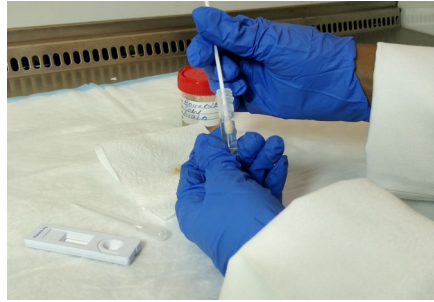

4. Homogenise the tissue using the swab until the sample has been dissolved into the assay diluent.

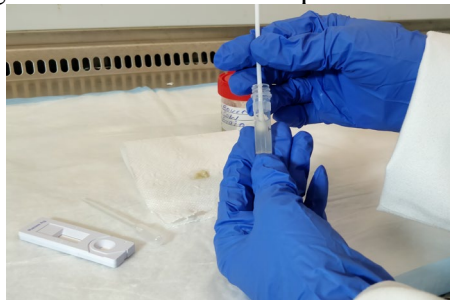

5. The test device shall be removed from the foil pouch and placed on a flat and dry surface.
6. Using a disposable dropper provided, take the sample suspension from the assay diluent tube.
7. Three to four drops of sample suspension shall be added into the sample pad of test device drop by drop vertically and slowly.

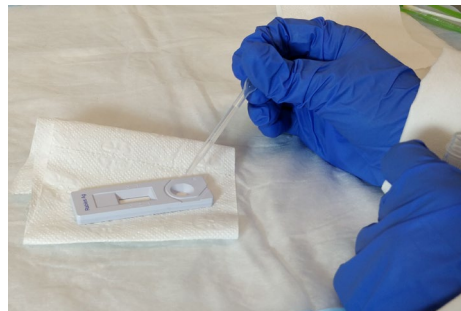

8. The test results shall be interpreted after 5-10 minutes. Reading shall not be taken after 20 minutes.

Interpretation of the test results:



- **Positive result:** Presence of red coloured Test (T) line and control (C) lines in the result window indicates the presence of rabies viral antigen in the brain tissue sample.
- **Negative result:** Presence of only red coloured control (C) line in the result window indicates the absence of rabies viral antigen in the brain tissue sample.
- **Invalid result:** If the red coloured control (C) line does not appear in the result

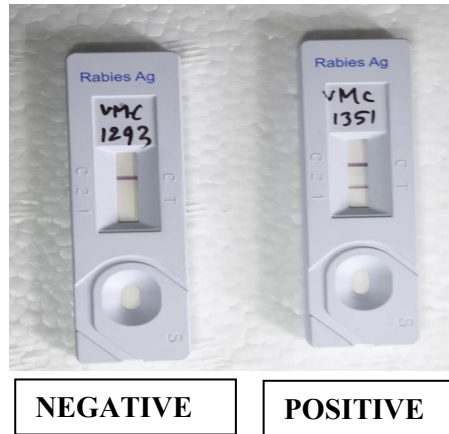

Lateral flow immunoassay is a simple and user-friendly test and can be used at the field level for the diagnosis of rabies in animals as a preliminary test. The assay is rapid, easy-to-perform, does not require any refrigeration, demonstrating its potential usefulness as a point-of-care assay for the diagnosis of many infectious diseases in resource-limited countries.

Direct Fluorescent Antibody (DFA) test

Sharada, R. and Kavitha, G.

Immunodiagnosis remains an important modality in the diagnosis of many diseases. A successful immunodiagnostic test depends on the use of highly specific and sensitive antigens as well as the detection of the appropriate antibody class or subclass. A variety of techniques, including Enzyme-Linked Immunosorbent Assays (ELISAs), Immunofluorescence Test, Immunoelectrophoresis, and Immunoblotting, have been used for the diagnosis of infections.

Principles of Immunofluorescence

Direct Fluorescent Antibody (DFA) test (Immunofluorescence test) was originally developed and established by Coons *et al.* (1942). Immunofluorescence test (IFT) is a serological test where the labeling of antibodies or antigens is done with fluorescent dyes (fluorochromes). Fluorochromes are the dyes which have the ability to absorb the short wavelength UV radiation (excitation) and emit light of longer wavelength (emission) which has the ability to fluoresce. The most commonly used fluorescent dyes are Fluorescein isothiocyanate (FITC) and Rhodamine, but other highly fluorescent substances (Phycocerythrin and Phycobiliproteins) have also come into use. Fluorescein absorbs blue light and emits an intense apple green fluorescence, Rhodamine absorbs yellow-green range and emits a deep red fluorescence, Phycocerythrin is efficient absorber of slightly blue-green/yellowish light and emits slightly orange-yellow fluorescence.

The specific antibodies labelled with fluorescent dyes which are called fluorescent antibody conjugates are used for detection of specific antigen in the preparation for examination by fluorescent microscopy which is illuminated by mercury lamp source and equipped with some combined filters.

There are two methods in IFT, direct immunofluorescence and Indirect immunofluorescence test. Direct immunofluorescence test is used for the detection of pathogens or their antigens in tissues or pathological samples. Briefly, in the direct immunofluorescence test, antigens are fixed on the glass slide, Fluorescein labeled antibodies are layered over it and incubated for an hour. The glass slide is washed to remove unbound antibody conjugates. Then the slide is examined under fluorescent microscope. The site where the antibody attaches to its specific antigen will show apple green fluorescence if FITC conjugates are used.

Indirect immunofluorescence test is used for the detection of antigen specific antibodies in the test serum samples or antigen in the pathological samples. For the detection of antibodies, known antigen is fixed on to the glass slide, test serum sample is layered over the antigen, after incubation for one hour, anti-species antibody (Anti immunoglobulin) conjugated with FITC is added, incubated, washed and observed for the fluorescence under fluorescent microscope. For the detection of antigen, antigens in the test sample are fixed on to the glass slide, monoclonal antibody specific for the antigen is added, incubated for an hour, Anti mouse antibody conjugated with FITC is then layered over it, incubated, washed and observed for fluorescence under fluorescent microscope.

Direct Fluorescent Antibody (DFA) Test for Rabies

The most commonly and widely used test for the diagnosis of rabies is the DFA, which is recommended by both World Health Organization (WHO) and World Organisation for Animal Health (OIE) developed by Goldwasser and Kissling in 1957. This test requires the examination of a complete cross section of the brain tissue preferably the brain stem of the animals suspected of being rabid, thus, the test can only be performed post-mortem.

The DFA is one of the sensitive and specific test recommended by OIE. It primarily involves demonstration of the rabies virus 'Nucleoprotein (N) antigen' in fresh brain impressions of a suspected rabies case. The sensitivity of the DFA depends on the type and quality of the specimen. Deteriorated or decomposed samples which have lost their distinguishing structural characteristics, display substantial green colouration, liquefaction, dessication (loss of tissue during staining and presence of bacteria may indicate decomposition) are considered unsatisfactory samples. Partially and completely decomposed brains are not suitable for DFA test as it is very difficult to differentiate specific fluorescence due to N antigen from nonspecific fluorescence which may result from bacterial contamination and decomposed tissue. Also, in such tissue samples the rabies nucleoprotein may be denatured which results in a negative DFA result. Thus, reliable results are obtained only when fresh brain tissue is used.

The DFA test can also be applied to specimens preserved in 50% glycerol saline after rigorous washing of the specimens with Phosphate Buffered Saline (PBS). If the specimen has been preserved in a formalin solution, DFA may be done only after the specimen has been treated with a proteolytic enzyme. However, the DFA on formalin-fixed and digested samples is always less reliable and more cumbersome than when performed on fresh tissue.

The detailed protocol of DFA test that is standardized and being used for the routine diagnosis of rabies in animals at the KVAFSU-CVA Rabies Diagnostic Laboratory is given below:

Materials/reagents Required:

- Sample container with brain sample
- Positive and negative control brain samples
- BP blade with its holder
- Absorbent bench under pad (to work on inside the Biosafety cabinet)

- Microscopic slides
- Slide holders/Coplin jar
- Storage container for the fresh brain sample
- Acetone
- Phosphate buffered saline (PBS) (0.01 M Phosphate buffer, pH 7.4-7.6 prepared with 8.5 g sodium chloride, potassium phosphate monobasic 0.23g, potassium phosphate dibasic 1.46g, double distilled water to make up volume to one litre)
- Syringe filters of 0.45µm with syringes
- Sharps container for discarding BP blades
- Rabies virus anti nucleocapsid IgG-FITC conjugate
- Evans Blue (0.5% in PBS)
- Biological safety cabinet (Class II)
- -20 °C or -80 °C Freezer
- Moist chamber/ Humid chamber for incubating slides with conjugate
- Incubator (37 °C)
- Fluorescent Microscope

Conjugate titration

Commercially available antirabies FITC monoclonal antibody conjugate is used. Titration of working dilution of the conjugate is made to optimize the exact dilution of the conjugate that is to be used. For this,

1. Prepare serial two-fold dilutions (e.g., 1:10, 1:20, 1:40 etc) for the newly opened conjugate in PBS.
2. The impressions from known rabies positive (minimum two) and known negative brains (minimum two) are made in duplicates for each of the dilutions and fixed in chilled acetone at -20 °C for an hour.
3. The slides are stained using standard DFA protocol.
4. Each of the stained slides is to be read by at least two persons independently.
5. The consensus of the last dilution providing crisp and high fluorescent staining with minimal background fluorescence is considered as the end-point dilution of the reagent.
6. Determine a more precise working dilution by preparing limited dilutions of the conjugate (around the end-point dilution determined as in step 5).

For example, if the end-point dilution of the titration is 1:80, the conjugate should be retested at dilutions of 1:70, 1:80, 1:90, 1:100 and 1:110

7. Repeat steps 2-5
8. The working dilution of conjugate should be two steps more concentrated than the first dilution at which a fall-off in staining is observed.
For example, if the fall-off in staining or the intensity is diminished at a 1:110 dilution, the working dilution of the conjugate should be 1:90
9. Once the conjugate dilution is made, the working solution of conjugate is prepared at the optimum dilution, filtered using 0.45µm filters and stored for use at 4 °C.

Counter staining

To lower the background activity of the fluorescent dye and to provide the contrast, Evans Blue (0.5% in PBS) is used as a counter stain which is added to the working dilution of the conjugate. The stock solution (0.5% Evans Blue in PBS) is aliquoted and stored at 4 °C for up to 6 months. The tissue when stained with counterstain appears red. Evans Blue is used at a final concentration of 0.00125%.

DFA Protocol:

1. Preparation of DFA slides from brain sample

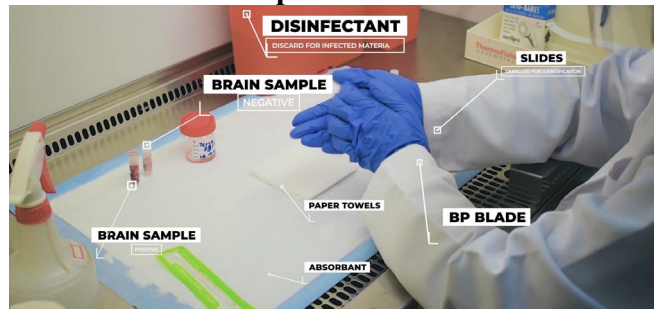

- Label the slides appropriately
- Work with one specimen at a time
- Take a small amount of the brain tissue (pea size) from the container and place it on the paper towel.

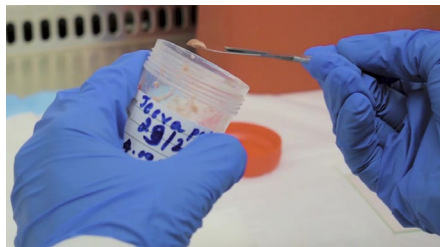

- Divide the tissue sections into multiple pieces

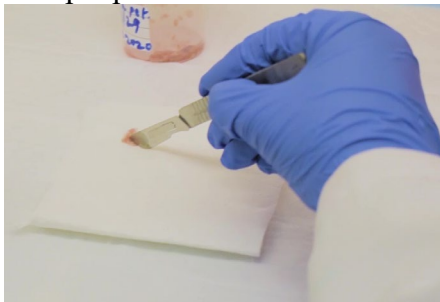

- Make brain impressions by gently touching the slide against the cut surface of the tissue

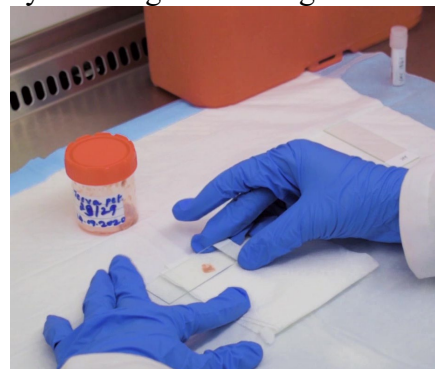

- For each of the test sample, two impressions are to be made
- The smears should be blotted onto paper towels to remove excess of moisture, tissue remains and blood stains (optional, if moisture is in excess)
- Allow the smears to air dry for 5-10 min



- A known negative (healthy brain sample) and a known positive (confirmed rabies sample) should also be included in the test as negative and positive control respectively. Prepare impressions from these as done for the test sample
- Place the slides in the slide holder / Coplin jar filled with chilled acetone



- Allow it for an hour at -20 °C / -80 °C or overnight at 4 °C

2. DFA testing for Rabies virus antigen

- Remove the slides from acetone and air-dry the slides at room temperature to ensure that the acetone traces on it are evaporated
- Place the slides in a moist chamber / humid chamber (to ensure the conjugate does not dry up during incubation)
- Add the working dilution of the conjugate so that it fully covers the impressions (Here we use 1:15 dilution of the above said FITC conjugate - approximately 50 µl per impression)

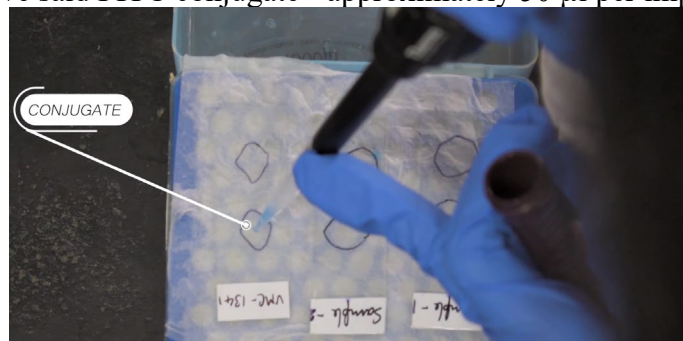

- Incubate the humid chamber at 37 °C for 30-45 min
- Drain excess conjugate from the slides and then wash with a gentle stream of PBS for 1-2 minutes.



- Invert slides on a paper towel to remove excess liquid from the slides (Take care not to press down on the slides to blot the impression)
- Set the slides on a paper towel lined tray to air dry
- Apply a small amount of 50% Glycerol in PBS (mountant) using a micropipette onto coverslip. One small drop is needed for each impression. Invert the stained slide onto the coverslip.

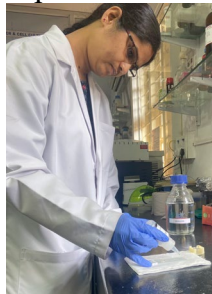

- The stained smears are observed under a fluorescent microscope.
- Slides should be read immediately if not the stain tends to fade due to photo bleaching. Stained slides be preserved for reference for weeks if stored at -20 °C.

3. Observation and interpretation of results

- The impressions are scanned for fluorescing inclusions at a magnification of approximately 200X
- Rabies virus in the brain of infected animal produces intracytoplasmic inclusions of various sizes and shapes
- When stained with FITC labeled antibody, these inclusions appear as glaring apple green areas, smooth with very bright margins and a somewhat less intensely stained central area.
- A single microscopic field may contain dust-like particles <1 µm in diameter and large round to oval masses and strings 2 to 10 µm
- Presence or absence of typical granular intra-cytoplasmic apple green fluorescence of aggregated viral nucleocapsids is used as the criterion in declaring positive and negative samples respectively.
- Slides should be read by two different persons

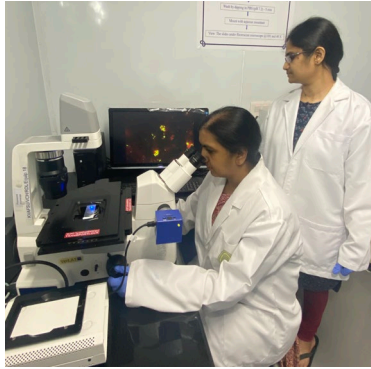

Nonspecific staining

- Presence of dull green or yellowish areas in a microscopic field is considered as non specific. Also, areas which take uniform bright green staining (as against bright margins and a somewhat less intensely stained central area which is typical of rabies virus inclusions).
- Diminished staining / weak staining intensity maybe the result of denaturation of rabies virus antigen or non-specific binding of antibody to components of inflamed tissue or artifacts of tissue decomposition.

DFA POSITIVE (note the bright apple green fluorescing foci)

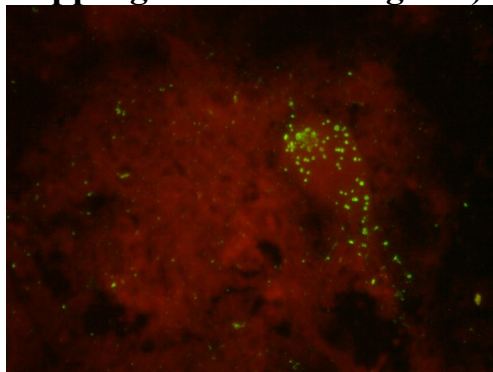
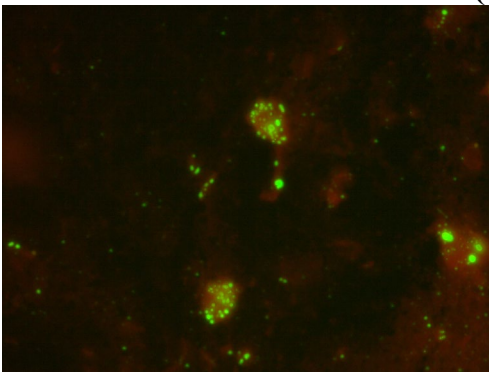

DFA NEGATIVE

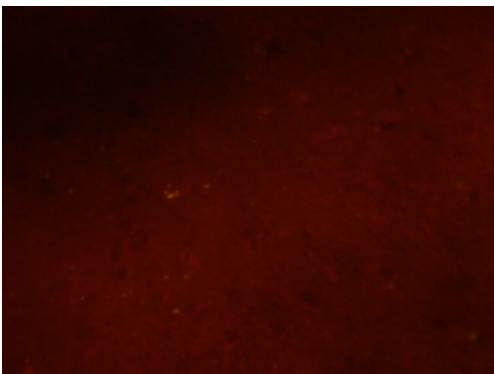

DFA NON SPECIFIC

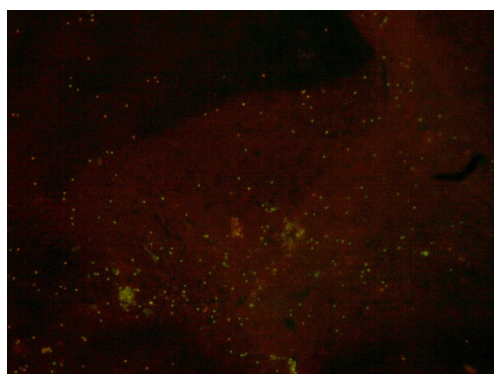

PUTRIFIED SAMPLE

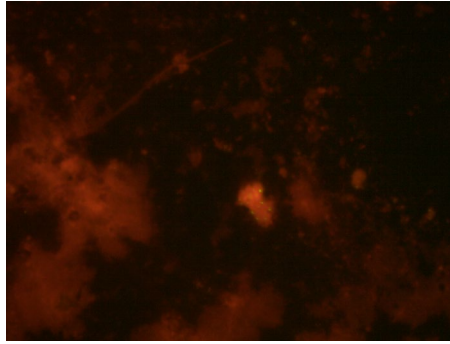

Documentation and reporting

Harshitha, N.



Laboratory based diagnosis is the basis for any disease surveillance and in turn implementation of disease control measures. As a part of this, scientific documentation and reporting are an integral part of any such testing laboratory or organization. KVAFSU-CVA Rabies diagnostic laboratory, OIE Reference Laboratory for Rabies, Dept. of Microbiology, Veterinary College, KVAFSU, Hebbal, Bengaluru, India is involved in routine diagnosis of rabies in animals by employing various tests and reporting. In the process, a plethora of documents including sample receipt format (Format 1), sample receipt book, temperature log chart (Format 2) for refrigerators, incubators and Deep freezers, entry-exit log books, equipment log books and equipment calibration books are maintained. The equipment operated in the laboratory are provided individual identification numbers and are calibrated annually for smooth functioning of the equipment and to obtain precise, reliable results. A day book is maintained by the laboratory personnel where the daily activities performed are recorded such as samples tested, procedure and result etc. Apart from processing the samples, another important aspect in the laboratory is maintaining cleanliness and the same is ensured through documentation vide Format 3.

As for the sample processing for diagnosis of rabies is concerned, initially, the sample is received along with a sample receipt form (Format 1). The sample details are documented in sample receipt book and a unique identification number is provided to each sample and is then processed. Being a BSL-2 facility, the entry to the laboratory is restricted to laboratory personnel only. The person entering the laboratory has to make entries such as name of the person, purpose and time of visit in the entry and exit log book placed at the entrance of the laboratory. The sample is then stored in the -20° C deep freezer until it is processed for testing.

The sample is processed in the core laboratory which also has a restricted entry. A log book is maintained in the ante room for making entries before moving into the core laboratory. In the ante room, the personnel should wear Personal Protective Equipment (PPE) including mask, double gloves, gown, safety glass and head cover. Once the samples are processed and results are read using the fluorescent microscope, it is documented in the respective forms and registers. The outcome of the test is immediately informed to the Veterinarian telephonically and the same is documented. Finally, the test report is prepared in a prescribed format (Format 4). It is then recorded in the sample receipt book and uploaded in the data base for further analysis.

Documentation is a must, “If it’s not documented, it didn’t happen”

Format 1

 <p style="text-align: center;">KARNATAKA VETERINARY, ANIMAL AND FISHERIES SCIENCES UNIVERSITY, BIDAR KVAFSU-CVA RABIES DIAGNOSTIC LABORATORY OIE REFERENCE LABORATORY FOR RABIES DEPARTMENT OF VETERINARY MICROBIOLOGY VETERINARY COLLEGE, HEBBAL, BENGALURU – 560 024</p> 		
FORMAT		
FOR DIAGNOSIS OF RABIES IN SUSPECTED SAMPLES		
1	Species of Animal	
2	Stray / Owned	Stray <input type="checkbox"/> Owned <input type="checkbox"/>
3	(Name& Address along with Ward No., if Owned) (Location and Ward No. , if Stray)	
4	Sample Submitted by Name& Address	
5	Contact details:	E-mail: Phone No.: Mobile No.:
6	Reference No.	
7	Clinical Signs and Symptoms	
7	Gender	Male <input type="checkbox"/> Female <input type="checkbox"/>
8	Breed	
9	Age	
10	Colour	
11	Vaccination details	Notched / Non notched
12	Date of Sample collection / Date of Post mortem	
14	Sample type	
<p>Note: Brain samples should be sent in cold chain</p> <p style="text-align: right;">Signature of the clinician</p>		



KARNATAKA VETERINARY, ANIMAL AND FISHERIES SCIENCES UNIVERSITY, BIDAR



KVAFSU CVA RABIES DIAGNOSTIC LABORATORY

OIE REFERENCE LABORATORY FOR RABIES

DEPARTMENT OF VETERINARY MICROBIOLOGY, VETERINARY COLLEGE, BENGALURU

-20°C DEEP FREEZER TEMPERATURE LOG

Equipment ID: KVAFSU / VCH/RDL/ Equip.16

Range: -20°C

Months	1	2	3	4	5	6	7	8	9	10	11	12	13	14	15	16	17	18	19	20	21	22	23	24	25	26	26	27	28	29	30	31	Sign of Supervisor				
May-2020																																					
June-2020																																					
July-2020																																					
Aug-2020																																					
Sep-2020																																					
Oct-2020																																					
Nov-2020																																					
Dec-2020																																					

Format 3.





**KARNATAKA VETERINARY, ANIMAL AND FISHERIES SCIENCES
UNIVERSITY, BIDAR**
KVAFSU-CVA RABIES DIAGNOSTIC LABORATORY
OIE REFERENCE LABORATORY FOR RABIES
DEPARTMENT OF VETERINARY MICROBIOLOGY
VETERINARY COLLEGE, HEBBAL, BENGALURU - 560 024



Room: Office & Corridor **Month: November 2020**

Date	1	2	3	4	5	6	7	8	9	10	11	12	13	14	15	16	17	18	19	20	21	22	23	24	25	26	27	28	29	30
Chemical used	S							S							S							S								S
Sweeping	U							U							U							U								U
Mopping	N							N							N							N								N
Surface cleaning	D							D							D							D								D
Cleaning the bins	A							A							A							A								A
Sign of cleaner	Y							Y							Y							Y								Y

Sign of supervisor

	<p>KARNATAKA VETERINARY, ANIMAL AND FISHERIES SCIENCES UNIVERSITY, BIDAR KVAFSU-CVA RABIES DIAGNOSTIC LABORATORY OIE REFERENCE LABORATORY FOR RABIES DEPARTMENT OF VETERINARY MICROBIOLOGY VETERINARY COLLEGE, HEBBAL, BENGALURU – 560 024</p>											
<p>No. RDL / VCH / VMC No / 2020-21/</p>		<p>Date:</p>										
<p><u>TEST REPORT FOR RABIES</u></p>												
1	Sample											
2	Animal / Species and Its Location											
3	Sample received from (Name & Address of sender)											
4	Date of sample Receipt											
5	Condition of the sample											
6	Date of Test performed											
7	Test performed											
<p>TEST RESULT:</p> <table border="1" style="width: 100%; border-collapse: collapse;"> <thead> <tr> <th style="width: 5%;">SL. NO.</th> <th style="width: 15%;">SAMPLE ID</th> <th style="width: 15%;">LAB ID</th> <th style="width: 45%;">TEST PROTOCOL</th> <th style="width: 20%;">RESULTS</th> </tr> </thead> <tbody> <tr> <td style="text-align: center;">1</td> <td></td> <td></td> <td style="text-align: center;"> OIE Manual of Diagnostic Tests and Vaccines for Terrestrial Animals, 2019, SOP No. RDL 027, DOI 02.09.2019 </td> <td></td> </tr> </tbody> </table>			SL. NO.	SAMPLE ID	LAB ID	TEST PROTOCOL	RESULTS	1			OIE Manual of Diagnostic Tests and Vaccines for Terrestrial Animals, 2019, SOP No. RDL 027, DOI 02.09.2019	
SL. NO.	SAMPLE ID	LAB ID	TEST PROTOCOL	RESULTS								
1			OIE Manual of Diagnostic Tests and Vaccines for Terrestrial Animals, 2019, SOP No. RDL 027, DOI 02.09.2019									
<p>Reviewed by:</p> <p style="margin-left: 40px;"> 1. (Shrikrishna Isloor) Laboratory Director </p>		<p>Authorized by:</p> <p style="margin-left: 40px;"> 2. (Sharada, R) Quality Manager </p> <p style="margin-left: 40px;"> (D. Rathnamma) Biosafety Officer </p>										



Videography by: Rohit Shankar

KVAFSU-CVA Rabies Diagnostic Laboratory Team



From Left to Right: Samrudh, M.C., Dilip, L., Isloor, S., Rathnamma, D., Sharada, R., Hridya, S.V., Kavitha, G., Sheela.

Annexures 1. Training Agenda

Day 1, Thursday 5 November 2020

9:00 am Kabul; 9:30 am Islamabad and Male'; 10 am Colombo and New Delhi; 10:15 am Kathmandu; 10:30 am Dhaka and Thimphu)

Introductory Session (30 minutes)

Topic	Speaker	Time (GMT+9)	Duration
Introduction and welcome	Dr Kinzang Dukpa	1:30 – 1:35 pm	5 min
Keynote remarks	Dr Hirofumi Kugita, Regional Representative, OIE RRAP	1:35 – 1:40 pm	5 min
	Dr H.D. Narayanaswamy, Hon'ble Vice Chancellor, KVAFSU, Bidar, India	1:40 – 1:45 pm	5 min
	Dr S. Abdul Rahman, Executive Director, CVA, Bengaluru, India	1:45 – 1:50 pm	5 min
	Dr Praveen Malik, Animal Husbandry Commissioner, DAHD, Government of India, New Delhi, India	1:50 – 1:55 pm	5 min
Training objectives and outline of the training	Dr Shrikrishna Isloor, Lab. Director, KVAFSU-CVA RDL, Veterinary College, KVAFSU, Hebbal, Bengaluru, India	1:55 – 2:00 pm	5 min
Presiding official's remarks	Dr. M. Narayana Bhat, Dean, Veterinary College, KVAFSU, Hebbal, Bengaluru, India		30 min
Total			

Day 1. Technical Session (2 hours 30 minutes)

Topic	Speaker/s	Time (GMT+9)	Duration
Introduction to the KVAFSU-CVA RDL's capacity and what support services are available from this OIE Reference Laboratory for Rabies including an overview of the latest advances in rabies diagnostic techniques	Dr Shrikrishna Isloor Dr D. Rathnamma Dr Sharada, R. KVAFSU-CVA RDL	2 – 2:30 pm	30 min
Theory session on the Occipital foramen approach for brain sampling, including sample preparation, sample transport and sample preservation	Dr Shrikrishna Isloor KVAFSU-CVA RDL	2:30 – 3 pm	30 min
Comfort break		3 – 3:10 pm	10 min
Practical demonstration / video	Mr. Dilip, L. & Dr. Samrudh, M.C. KVAFSU-CVA RDL	3:10 – 3:50 pm	40 min
Q & A		3:50 – 4:20 pm	30 min
Training wrap-up	OIE RRAP/KVAFSU	4:20 – 4:30 pm	10 min
Total			150 min

Day 2, Friday 6 November 2020 (3 hours)

Topic	Speaker	Time (GMT+9 hours)	Duration
Introduction and welcome	OIE RRAP	1:30 – 1:35 pm	5 min
Regional Situation of Rabies Diagnostic Capacity in the SAARC region.	OIE RRAP	1:35 – 1:45 pm	10 min
Theory session on lateral flow Immunoassay	Dr. D. Rathnamma KVAFSU-CVA RDL	1:45 – 2:05 pm	20 min
Practical demonstration on lateral flow Immunoassay	Dr. Hridya Susan Varughese KVAFSU-CVA RDL	2:05 – 2:25 pm	20 min
Comfort break		2:25 – 2:35 pm	10 min
Theory session on Direct Fluorescent Antibody (DFA) test	Dr. Sharada, R. KVAFSU-CVA RDL	2:35 – 3:05 pm	30 min
Practical demonstration / video on Direct Fluorescent Antibody (DFA) test	Dr. Kavitha, G. KVAFSU-CVA RDL	3:05 – 3:40 pm	35 min
Documentation and reporting	Mrs. Harshitha, N. KVAFSU-CVA RDL	3:40 – 3:55 pm	15 min
Q & A		3:55 – 4:15 pm	20 min
Training wrap-up (closing session)	OIE RRAP/KVAFSU	4:15 – 4:30 pm	15 min
Total			180 min

Note: OIE RRAP – OIE Regional Representation for Asia and the Pacific (Tokyo); **KVAFSU** – Karnataka Veterinary, Animal and Fisheries Sciences University, Bengaluru; **CVA** - Commonwealth Veterinary Association; **RDL** - Rabies Diagnostic Laboratory

Annexures 2. List of participants

	Country	Name	Designation	Remarks	E-mail
1	Bangladesh	Dr Provat Chandra Saha	Senior Scientific Officer, Rabies Vaccine Section, LRI, DHAKA	Country participant	provatsaha@yahoo.com ;
2	Bangladesh	Dr Mohammad Mufazzal Hossain	Senior Scientific Office, Veterinary Public Health, Livestock Research Institute, Mohakhali, Dhaka	Country participant	mdmufa@gmail.com ;
3	Bangladesh	Dr Shukes Chandra Badhy	Upazila Livestock Officer (L/R Post), Central Disease Investigation Laboratory, Dhaka	Country participant	badhy78@gmail.com ;
4	Bangladesh	Dr Md. Shohidul Islam Khokon	Veterinary Surgeon (L/R Post) DLS, Attached- Preventing Anthrax and Rabies in Bangladesh through Surveillance and Response (PARB) Project, DHAKA	Country participant	sikhokon84@gmail.com ;
5	Bhutan	Dr Sonam Jamtsho	Senior Veterinary Officer TVH & SL, Phuentsholing	Country participant	sjyurung@yahoo.com ;

6	Bhutan	Ms Kezang Lhamo	Laboratory Technician National Centre for Animal Health, Serbithang	Country participant	kelzanglhamo33@gmail.com ;
7	Bhutan	Mr Lungten Dorji	Senior Laboratory Technician Satellite Laboratory, Dewathang	Country participant	ldmomring@yahoo.com ;
8	Bhutan	Dr Tshewang Gyembo	Senior Veterinary Officer Satellite Laboratory, Gelephu	Country participant	gyembotshewang@yahoo.com ;
9	India	Dr. Harsh Kumar Sharma	Assistant Professor Division of Veterinary Public Health and Epidemiology, Faculty of Veterinary Sciences and Animal Husbandry, Jammu, UT of Jammu and Kashmir	Country participant	harshvphe@gmail.com ;
10	India	Dr. Amita Dubey	Assistant Professor, Department of Veterinary Pathology, College of Veterinary Sciences and Animal Husbandry, Jabalpur, M.P.	Country participant	amiabhishek@rediffmail.com ;
11	India	Dr. Suman Biswas	Assistant Professor PhD. Veterinary Medicine Department of Avian Sciences, Faculty of Veterinary and Animal Sciences, West Bengal University of Animal & Fisheries Sciences.	Country participant	sumanvet.09@gmail.com ;
12	Maldives	Dr Jesa Ken Polinar	Veterinarian Animal Health and Veterinary Services Section Ministry of Fisheries, Marine Resources and Agriculture	Country participant	kenpolinar@gmail.com ;
13	Maldives	Mr Lahfaan Moosa	Assistant Statistical Officer Animal Health and Veterinary Services Section Ministry of Fisheries, Marine Resources and Agriculture NFP for Animal Welfare	Country participant	Mlahfaan20@hotmail.com ;
14	Nepal	Dr Krishna Raj Pandey	Senior Veterinary Officer Regional Veterinary Laboratory Surkhet	Country participant	drpandeykr@yahoo.com ;
15	Nepal	Dr Sanjay Yadav	Senior Veterinary Officer Regional Veterinary Laboratory, Biratnagar	Country participant	sanjayyadav160@hotmail.com ;
16	Nepal	Dr Manish Man Shrestha	Veterinary Officer National Vaccine Production Laboratory, Kathmandu	Country participant	mmanshrestha@gmail.com ;
17	Nepal	Dr Manju Maharjan	Veterinary Officer Central Veterinary Laboratory, Kathmandu	Country participant	meet_davet@hotmail.com ;
18	Pakistan	Dr Muhammad Numan (Mr)	Senior Veterinary Officer (Research), Veterinary Research Institute, Lahore	Country participant	numan.vri@gmail.com ;

19	Pakistan	Dr Mobeen Sarwar (Ms)	Assistant Disease Investigation Officer, Provincial Disease Diagnostic Laboratory, Punjab	Country participant	adiolahore@gmail.com;
20	Pakistan	Dr Muhammad Fayaz (Mr)	Scientific Officer, National Veterinary Laboratories, Islamabad	Country participant	fayazkhandvm@gmail.com;
21	Pakistan	Dr Ali Raza Nizamani (Mr)	Research Officer, Central Veterinary Diagnostic Laboratory, Sindh	Country participant	draliraza414@gmail.com;
22	Sri Lanka	Dr S. Hettiarachchi	Addl. Director General (Animal Health) (Actg.) Director/Animal Health		sarathetti16@yahoo.com;
23	Sri Lanka	Dr Sumathy Puvanendiran	Veterinary Research Officer	Country participant	sumathypuva@gmail.com;
24	Sri Lanka	Dr P. Gunawardana	Senior Lecturer, Faculty of Veterinary Medicine & Animal Science	Country participant	pandukag@pdn.ac.lk;
25	India	Dr Abdul Rahman	Executive Director Commonwealth Veterinary Association Secretary, Animal Welfare and Wellness Committee of WSAVA	Invited Speaker	shireencva@gmail.com;
26	India	Dr Praveen Malik	Animal Husbandry Commissioner Department of Animal Husbandry and Dairying, India	Invited Speaker	ahc-dadf@nic.in;
27	India	Dr H. D. Narayanaswamy	Hon'ble Vice Chancellor Karnataka Veterinary, Animal and Fisheries Sciences University KVAFSU-CVA Rabies Diagnostic Laboratory	Invited Speaker	vckvafsub@gmail.com;
28	India	Dr Narayana Bhat	Dean, Veterinary College KVAFSU, Hebbal, Bangalore	Invited Speaker	deanvch@gmail.com;
29	India	Dr Shrikrishna Isloor	Laboratory Director KVAFSU-CVA RDL	Trainer	kisloor@gmail.com;
30	India	Dr D. Rathnamma	Prof. & Head, Dept of Microbiology and Biosafety Officer, KVAFSU-CVA_RDL, Veterinary College, Bengaluru	Trainer	rathnarohit@gmail.com
31	India	Dr Sharada R.	Assistant Professor, Dept of Microbiology and Quality Manager, KVAFSU-CVA_RDL, Veterinary College, Bengaluru	Trainer	sharadadr@yahoo.co.in
32	India	Mr. Dilip, L.,	Technical Manager, KVAFSU-CVA_RDL, Veterinary College, Bengaluru	Trainer	dilipgowda777143@gmail.com
33	India	Dr G. Kavita	Ph D scholar, Dept of Microbiology and Analyst - 1, KVAFSU-CVA_RDL, Veterinary College, Bengaluru	Trainer	drkavitha85@gmail.com
34	India	Dr. Samrudh, M.C.,	Sr. MVSc student, Dept of Microbiology and Analyst - 2, KVAFSU-CVA_RDL, Veterinary College, Bengaluru	Trainer	samrudhmahadi@gmail.com

35	India	Dr Hridya Susan Varughese	Ph D scholar, Dept of Microbiology and Analyst - 3, KVAFSU-CVA_RDL, Veterinary College, Bengaluru	Trainer	drhridyasv@gmail.com
36	India	Mrs Harshita N.	Data Entry Operator, KVAFSU-CVA_RDL, Veterinary College, Bengaluru	Trainer	harshitha71@gmail.com
37	Japan	Dr Hirofumi Kugita	Regional Representative, OIE RRAP	Organiser	h.kugita@oie.int
38	Japan	Dr Kinzang Dukpa	Regional Project Coordinator, OIE RRAP	Organiser	k.dukpa@oie.int ;
39	Japan	Dr Lesa Thompson	Regional Project Officer, OIE RRAP	Organiser	l.thompson@oie.int ;
40	Bhutan	Dr Pasang Tshering	OIE Consultant, OIE RRAP	Organiser	p.tshering@oie.int
41	Japan	Dr Maria Glofezita Lagayan	Intern, OIE RRAP	Organiser	joy.lagayan@outlook.com ;
42	Japan	Dr Maho Urabe	Regional Veterinary Officer, OIE RRAP	Observer	m.urabe@oie.int ;
43	Japan	Dr Tiangang Xu	Regional Project Officer, OIE RRAP	Observer	t.xu@oie.int

Annexures 3. Quiz questions and answers

Please choose **ONE** correct answer

- The genome of rabies virus comprises of:
 (a) **ss RNA** (b) ds RNA (c) ss DNA (d) ds DNA
- The ideal post-mortem sample to be collected in animals for laboratory confirmation of rabies is:
 (a) Saliva (b) Cerebrospinal fluid (CSF) (c) **Brain** (d) Corneal impression
- The preferred parts of the brain for detection of rabies viral inclusions are:
 (a) Hippocampus and cerebrum
 (b) Cerebrum and cerebellum
 (c) **Cerebellum and Brain stem**
 (d) Hippocampus and cerebellum
- Brain samples preserved in following are **unfit** for isolation of virus:
 (a) **Formalin** (b) Glycerol (c) Phosphate Buffered Saline (PBS) (d) None
- The rapid, preliminary test for diagnosis of rabies at the field level is:
 (a) Seller's staining
 (b) **Lateral Flow Assay (LFA)**
 (c) Fluorescent Antibody Test (FAT) / Direct Fluorescent Antibody (DFA) test
 (d) Direct Rapid Immunohistochemistry Test (dRIT)
- Clinical samples collected for rabies diagnosis should be packed as below for transportation to the laboratory:
 (a) As such without the need of any packing / cold chain

- (b) 1-tier system of packing in cold chain
 - (c) 2-tier system of packing in cold chain
 - (d) 3-tier system of packing in cold chain**
7. The most widely used test for rabies diagnosis is:
 (a) Polymerase Chain Reaction (PCR) **(b) dRIT** (c) FAT / DFA (d) Seller's staining
8. Following is the immunochromatography-based diagnostic test for rabies:
 (a) Immunohistochemistry (IHC) **(b) LFA** (c) dRIT (d) None
9. The commonly used counter stain in FAT / DFA in most rabies diagnostic laboratories is:
(a) Evan's blue (b) Methyl red (c) Phenol red (d) Gill's haematoxylin
10. Direct rapid immunohistochemistry test (dRIT) employs the following type of microscope:
 (a) Fluorescent microscope **(b) Light microscope**
 (c) Electron microscope (d) Dark field microscope

(Key: Answers in BOLD)

Annexures 4. Summary of training evaluation

Evaluation Summary

Total responses = 24

1. Overall assessment of the training:

Highly satisfied: 13(54%)

Satisfied: 11 (46%)

■ Highly Dissatisfied
 ■ Dissatisfied
 ■ Neutral
 ■ Satisfied
 ■ Highly satisfied



2. How would you rate the impact this training will have on:

your technical knowledge on the subject

Highest impact: 6 Significant impact: 17 Neutral: 1

your undertaking rabies activities in the future

Highest impact: 7 Significant impact: 15 Neutral: 1 Small impact: 1

your strengthening national/regional/international rabies networks:

Highest impact: 6 Significant impact: 16 Neutral: 2

■ No impact
 ■ Small impact
 ■ Neutral
 ■ Significant impact
 ■ Highest impact



3. Please rate how useful you found for each of the technical sessions.

Introduction to KVAFSU-CVA RDLs laboratory capacity

Very useful: 10 Useful: 12 Neutral: 2

Theory session on Occipital Foramen approach of brain sampling

Very useful: 17 Useful: 6 Neutral: 1

Practical session on Occipital Foramen approach of brain sampling

Very useful: 17 Useful: 5 Neutral: 2

Regional situation of rabies diagnostic capacity in the SAARC region

Very useful: 10 Useful: 12 Neutral: 1 Not very useful: 1

Theory session on lateral flow immuno assay

Very useful: 15 Useful: 7 Neutral: 2

Practical session on lateral flow immuno assay

Very useful: 14 Useful: 8 Neutral: 2

Theory session on Direct Fluorescent Antibody (DFA) test

Very useful: 15 Useful: 8 Neutral: 1

Practical session on Direct Fluorescent Antibody (DFA) test

Very useful: 12 Useful: 10 Neutral: 2

Documentation and reporting

Very useful: 12 Useful: 12

■ Not useful
 ■ Not very useful
 ■ Neutral
 ■ Useful
 ■ Very useful

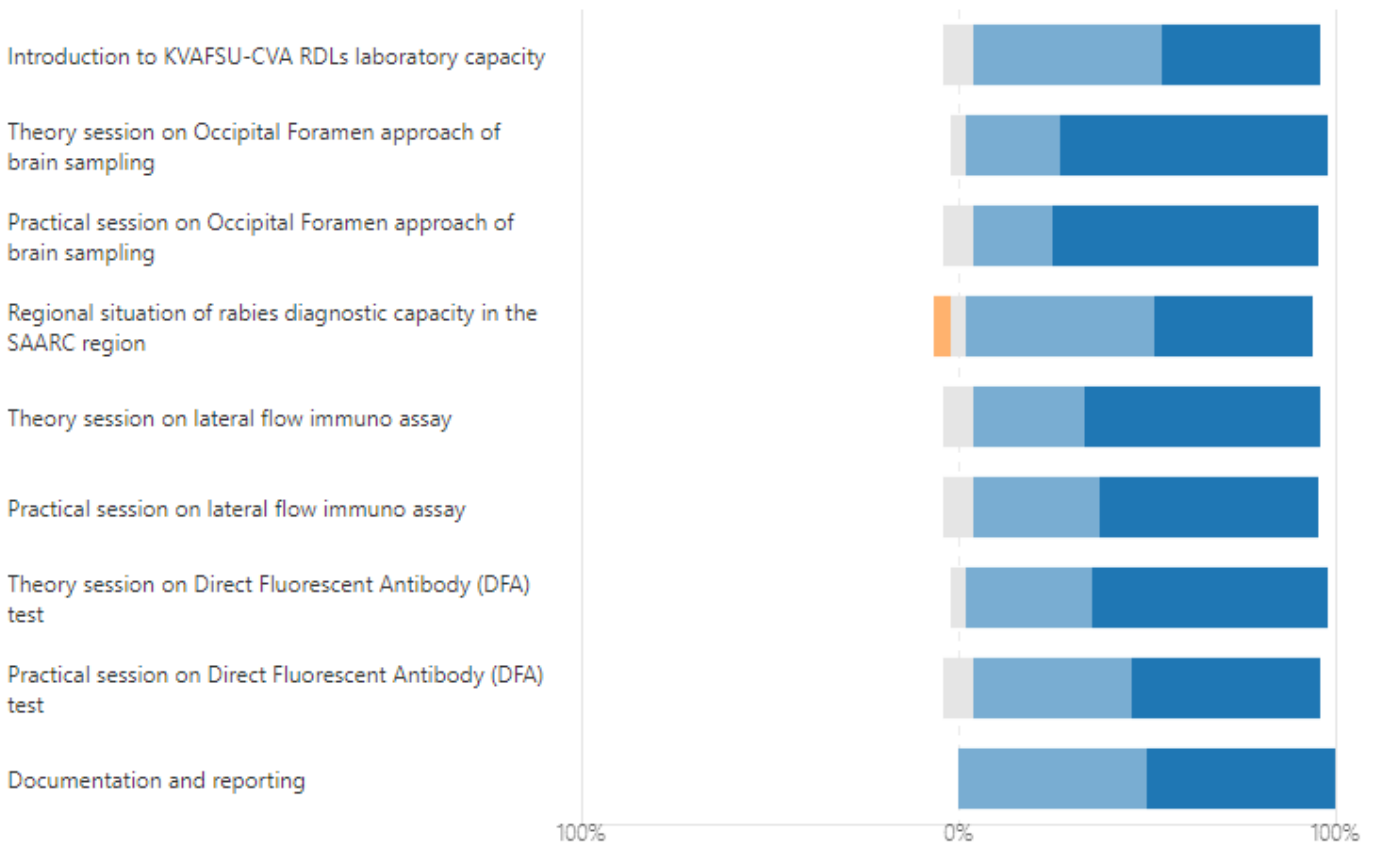

■ Highly Dissatisfied
 ■ Dissatisfied
 ■ Neutral
 ■ Satisfied
 ■ Highly satisfied



5. What did you like about this training?

- The contents were very good as well as the way of presentation and video demonstration
- The technique of sampling the brain adopting the occipital foramen approach.
- Guidance and support for initiating the project concern with Rabies
- it was an excellent virtual training session in which staying at our offices/labs we got benefit from world renowned professionals in the field of rabies with the cooperation of OIE organizers
- Practical session and Q and A session
- Having global target of dog mediated rabies elimination by 2030, this training comes at an opportune time. Such trainings will enhance the technical and practical competency of oneself.
- The field activities shown through different activities
- Learned a lot about laboratory diagnostics that I did not know about before for rabies
- Gained knowledge about rabies sampling and latest technique of rabies diagnostic procedure
- The training sessions were of convenient timing and duration and we could participate it without taking the risk of travelling. It was also useful to know how rabies diagnosis is carried out in another SAARC country.
- The topics, theory and practical demonstrations were excellent.
- Time management was perfect - Short and sweet training

6. Suggest what could have been improved in this training?

- handling fluorescent microscopy demonstration,
- The practical video clip should be clear for the participants.
- More practical activities
- Please make arrangement for live practical demonstration in hostile environment.
- More time on practical aspects would have been more knowledgeable.
- More videos must be included to demonstrate it more effectively although its wonderful training.
- Sample collection Method
- More details on regional situation of rabies diagnostic capacity in the SAARC region particularly, the limitations and drawbacks, and how to overcome them could have been useful.
- Better if a bit more effort given in videography.

7. What other topics on rabies diagnosis would you like to see covered in the future trainings?

- handling fluorescent microscopy demonstration
- Rabies diagnosis in live animals
- The epidemiology of rabies in different countries and the laboratory capacity and the various testing protocols employed in different countries.
- Biosecurity measures and lay out of rabies laboratory
- Other tests like immunohistochemistry, Real Time PCR and Conventional PCR and ELISA needs to be explored.
- Serological testing and vaccination monitoring

- Production of rabies vaccine

8. List TWO MOST important tasks you will do following this training to support rabies diagnosis and surveillance in your country.

- I will continue rabies diagnosis in my laboratory and contribute rabies surveillance
- Collection of brain sample using occipital foramen and documentation
- Revive the diagnosis of rabies employing DFA.
- workout for DFA test establishment in my lab and developing questionnaire for taking data from stray dog populated areas in my region.
- Starting the sample collection for Rabies diagnosis by Occipital foramen approach. Encouraging the sample collection for rabies by field Veterinarian and training them for Occipital approach.
- Disseminate my knowledge to my colleagues specially on LFA. Help to assist on diagnostic techniques
- Equipment of laboratory with LFA kit
- Use Occipital foramen method for Rabies sampling. Initiate DFA/FAT in our satellite laboratory as soon as possible.
- Share what approaches OIE and stakeholders are taking for control of Rabies. What are the best samples for laboratory diagnosis and which technique is the best to perform.
- Talk to my superiors on ways to strengthen the plans for any future rabies outbreak. Team up with health sector shareholders on ways to improve laboratory conditions for the testing of rabies and other animal diseases
- rapid diagnosis in the field and sample packing
- As Maldives is Rabies Free country, laboratory facility still on process of funding but we are looking forward for that.
- I am carrying out the LAF test in my lab.
- Try to transport samples properly to laboratory for diagnosis and assist mass vaccination in our country for the elimination of rabies by 2030
- Rabies control and mass dog vaccination
- Regular Rabies diagnostic work in our laboratory and occipito-atlanto approach of brain sample collection

Annexure 5. Q & A

Note: If further clarifications are required, please directly contact the speakers/ experts ((Dr Shrikrishna Isloor – kisloor@gmail.com) or refer to the relevant publications.

DAY 1 (November 5, 2020)

Introduction to the KVAFSU-CVA RDL's capacity and what support services are available from this OIE Reference Laboratory for Rabies including an overview of the latest advances in rabies diagnostic techniques

Rabies laboratory facilities

1.1. What are the basic infrastructure requirements and recommendations in the laboratory to start rabies diagnosis?

It can just be a simple laboratory with horizontal laminar flow biosafety cabinet. It is recommended that the laboratory has secured entry and partitions, proper disposal system/

facility, a -20 to -80 deep freezer, an anteroom (change room), sterilization room, a good quality fluorescent microscope in addition to incubator, autoclave, refrigerators, sensitive balance, micropipettes etc. (see picture below for layout of rabies diagnostic laboratory) Dr Isloor has shared the image depicting the layout of their laboratory. For further details you can email rdlkvafsucva@gmail.com.

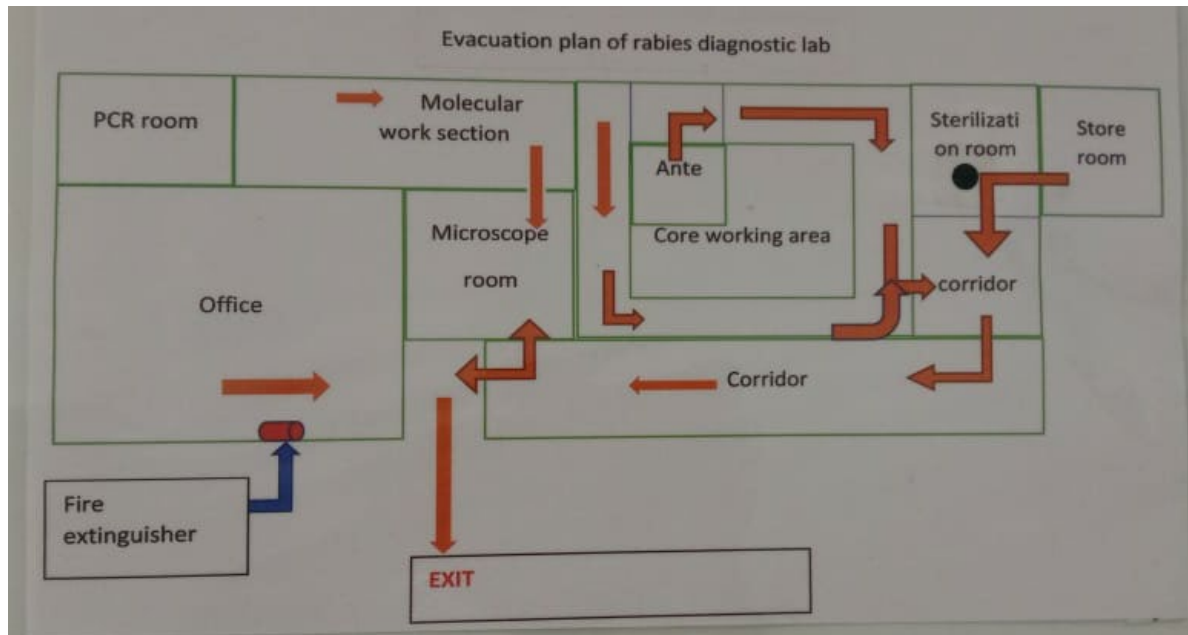

Theory session on the Occipital foramen approach for brain sampling, including sample preparation, sample transport and sample preservation, and practical demonstration (video)// Theory session on lateral flow assay and practical demonstration (video)

Cold Chain

2.1. What is your recommendation for storage of brain samples in cold chain?

For short term storage (a few hours), 4° Celsius is alright. The sample can be kept for up to 1 week if maintained properly in this temperature.

If processing might be delayed, then storage in -20° degrees Celsius is preferred.

2.2. Are gel packs useful for sample shipment?

Frozen gel packs, when properly used, can maintain the cold chain for approximately 36 hours.

Sample collection

3.1. In the occipital foramen approach for brain sampling, why did they not use a syringe in the straw technique?

This was done for convenience during sample collection. The straw was pinched at the end during collection to create a vacuum. This has almost the same principle when using a syringe. We have used the disposable syringe connected to the AI sheath in collection of brain sample through Occipital foramen approach and the same has been demonstrated in the practical session.

3.2. There are biosafety concerns in the field because of exposure risk and improper disposal of rabies suspected carcasses during the sample collection activities. What are your views and experiences on biosafety measures at the field level?

The use of basic Personal Protective Equipment (PPE) and the occipital foramen approach for

sample collection is safer, especially when using the straw method. However, those collecting the brain sample must be immunized against rabies. As for the disposal of the carcass, incineration is the preferred method to use. An acceptable alternative is to bury the carcass at least 4 feet deep and covered with lime.

3.3. How can we conduct an early rabies diagnosis in live animals?

We can conduct tests using saliva from suspected animals. However, it is to note that virus is shed intermittently in saliva and therefore a single test may not detect the virus. Therefore, multiple sampling is needed. Collect at least 3 samples at 3 different times every 2 hours span. Pool the samples and then test using LFA or PCR. Not DFA.

For sampling in live animals, utmost consideration should be given for safety of the collector especially with aggressive animals. If an animal is cooperative or if person is well immunized and protected with PPE then saliva can be collected. In dumb form / paralytic form it is easier to collect samples. Safety should be the first priority when dealing with live suspected animals. Hair follicles can be used as sample and gives good results, but only using PCR.

3.4. For PCR technique from hair follicles, is it the hair from the neck region we need to collect?

Yes. Literatures indicate the hair follicles from the neck region. PCR on the hair follicle should be hypothetically working on most species. But availability of PCR in all the labs, expertise, reagents should be ensured.

3.5. If the carcass is completely putrefied, do you still recommend collecting samples?

Yes, putrefied samples can still be tested using PCR.

Disposal

4.1. How do you dispose rabies affected carcass after sample collection?

Of all the common methods of carcass disposal (incineration, burying, and rendering), incineration is the preferred method to use, however, cost should be considered since it can be expensive. An acceptable alternative is to bury the carcass. For burying, the carcass should be buried at least 4 feet deep and covered with lime to discourage scavengers from uncovering and consuming it.

DAY 2 (November 4, 2020):

Continued discussion on lateral flow assay (LFA)

LFA: specificity, sensitivity, availability, cost, and how to discard

5.1 What is the specificity and sensitivity of the LFA test under field conditions? Any precautions to consider while performing the test?

Current studies at KVAFSU-CVA-RDL showed test sensitivity between 98.5 to 99% and specificity nearly 100% (unpublished). If the LFA tests negative, it must be confirmed by DFA (gold standard test).

Currently, the LFA test provided by the WHO-SEARO is undergoing validation. It is working almost at par with the Direct Fluorescent Assay (DFA). At times when partially putrefied brain samples are tested, the virus can still be detected by the LFA while such samples are unfit to be tested by DFA. However, this test is still used as a preliminary test.

It should be considered that while the LFA is a user friendly and rapid test, it is important to select the best quality kit available, that is well validated.

5.2 Where is the LFA kit available and what is preferred brand in the market?

The LFA kit (@BioNote) used by KVAFSU-CVA Rabies Diagnostic Laboratory is supplied free by WHO SEARO.

Preference purely depends on how the kits are validated. Some LFA kits available in the market are yet to be validated and standardized/ optimized. India is actually developing an

indigenous LFA kit through a PhD student, to make it more localized and cost effective.

5.3 What is the cost of an LFA test?

It costs around 400 to 500 Indian Rupees for one cassette. One pack comes in a set of 10. DFA is cheaper and recommended, however LFA is more user-friendly and can be used in field conditions, if made more cost effective.

5.4 How can we properly discard the used LFA cassette?

It can be done through spraying of 70% ethyl alcohol on the cassettes or dipping it in 2% sodium hydroxide to inactivate the virus before discarding.

Theory session on Direct Fluorescent Assay (DFA) and practical demonstration (video)

Sample processing and reading

6.1 Is FITC filter with green light excitation usable or should it be a blue filter?

Excitation filters will filter all colors except blue. The FITC conjugated to anti N protein Monoclonal antibody (which in turn is bound with N antigen of the rabies virus in the tissue impression) on being exposed to blue light, emits green light. The emission filter allows transmission of green light which can be seen through the microscope.

6.2 What is the difference between double dilutions and log dilutions?

1:2, 1:4, 1:8 and 1:16 are double dilutions. Likewise, 1:10, 1:20, 1:40 and 1:80 are also double dilutions or two-fold dilutions. Whereas, 1:10, 1:100, 1:1000 are tenfold dilutions or log dilutions. We employ the 10-fold or log dilutions only when we need to titrate the load /titre of virus.

6.3. Can you briefly describe the process of washing of sample with PBS?

Take the PBS in a petri dish. Immerse the brain tissue, gently shake...discard the wash carefully...then repeat a couple of times.

6.4. Does sparse or weakly staining inclusions mean sample is negative for rabies or do you do a re-test?

Declaring a positive result is easy but if it is negative, then we need to retest 2 times more (total 3 times). Visualization could be done at 200 - 400X. DFA's sensitivity depends on the quality of reagents, especially conjugates.

6.5. How do you store the positive and negative samples and for how long?

Storing the samples at -80° deep freezer is the best way to keep it. If it is not there, -20° is also OK. But ensure that there is no power failure to avoid repeated freezing and thawing that could deteriorate the quality of samples.

Such samples can be used for retrospective molecular epidemiological studies, or for other purposes.

6.6. What is the concentration and dilution of all types of reagents and washing solution?

Dilutions of reagents are provided in the manual. However, with reagents we must employ end point titration, especially for conjugates, and then decide the working strength.

6.7. Does the virus lose its infectivity following acetone fixation?

Yes, acetone fixation fixes the tissue as well as almost inactivates the infectivity of the virus. Hence one must use double gloves while processing and handling DFA slides.

6.8. Which FITC reagent/kit are you using in your laboratory?

We use Millipore-Light diagnostics or Fujirebio anti N protein Mab based FITC conjugates .

General

7.1. Can we use the same diagnostic tests used in domestic animals for diagnosis of rabies in wild animals?

Yes, you can use the same tests for diagnosis of rabies in wild animals too.

Annexures 6. Training in pictures

